

90deg Corner post 116200
Steel reinforcement adjustment nut 113128 141444
LOAD BEARING

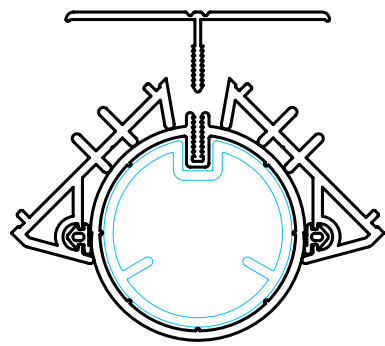

Bay pole cover 116047
Aluminium bay pole 104157
Bay pole shoe 116049
Gasket 112003
Cover piece 116048
adjustment nut 141437.2
LOAD BEARING

bay poles

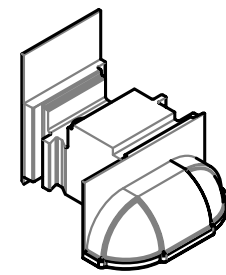

False Mullion End Cap Moulding 109525 LH/RH (for 102265)

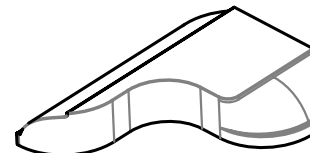

Casement Horn Cover Moulding 109549 LH/RH

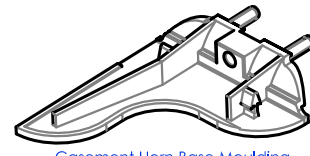

Casement Horn Base Moulding 109539 LH/RH



Casement Run-up Block 109380

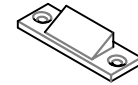

Cavity Locking Wedge 109265



Drain Slot Cover 109267

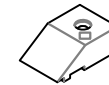

Tilt & Turn / Door Run-up Block 109398

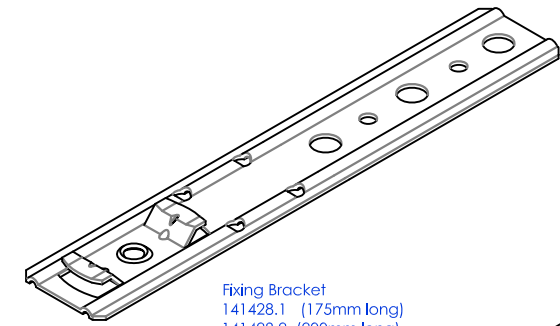

Fixing Bracket 141428.1 (175mm long)
141428.2 (200mm long)
141428.3 (250mm long)

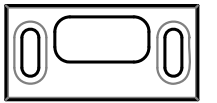

Shoot Bolt Keep Plate 141126

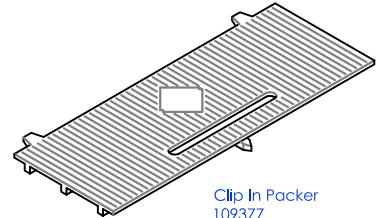

Clip In Packer 109377

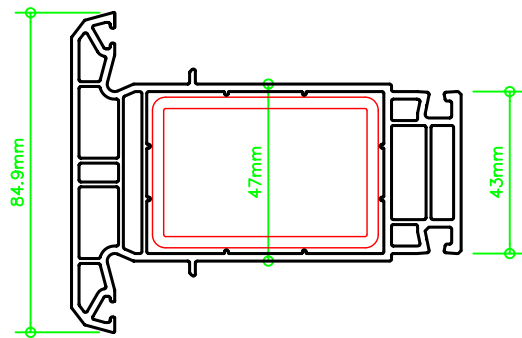

Coupling profile 116.202
Steel reinforcement 113.011
adjustment nut 141.439

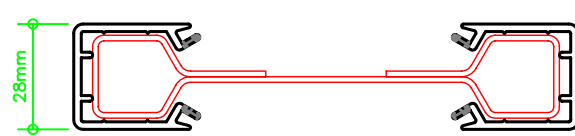

dogbone coupling covers 113112 116012

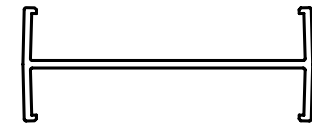

small H coupling 116058

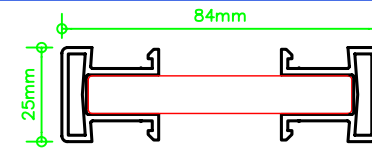

coupling cover reinforcement 116029 113119 (solid)

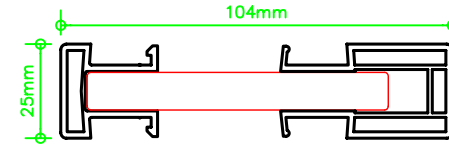

coupling covers reinforcement 116028 & 116029 113120 (solid)

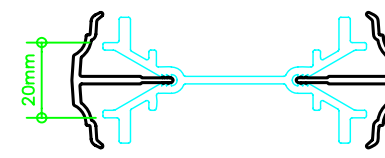

cover profile aluminium reinforcement 116060 104210



coupling 116030



coupling 116005

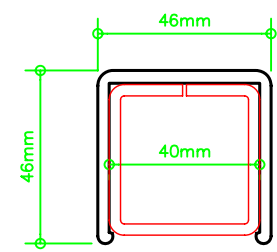

cover profile Steel reinforcement 109195 113128

couplers

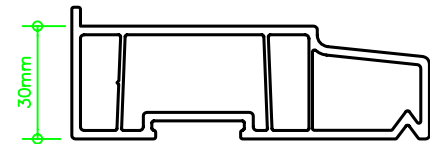

95mm Cill reinforcement end cap 110074 113317 113245 109074

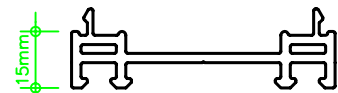

15mm frame extension 114028

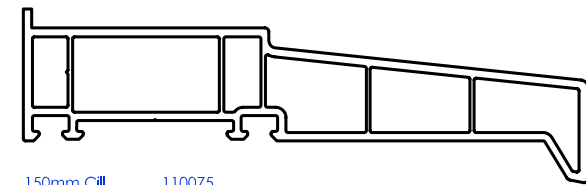

150mm Cill reinforcement end cap 110075 113377 109085 109084 109089 109075

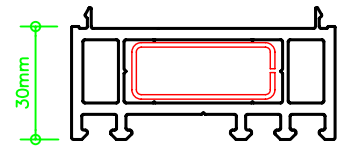

30mm frame extension Reinforcement 114014 113073

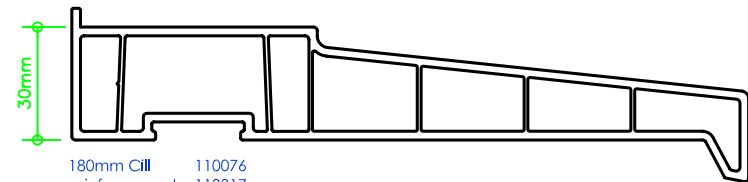

180mm Cill reinforcement end cap 110076 113317 113245 109090

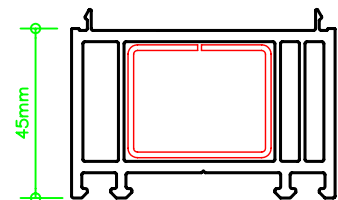

45mm frame extension Reinforcement 114202 113271

cills & extensions

drips & beads



beadgroove infill 112380



Eurogroove Infill 109045

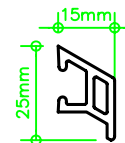

drip mould end cap 109030 109140



drip mould end cap 109122 109141

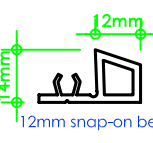

12mm snap-on bead 109115

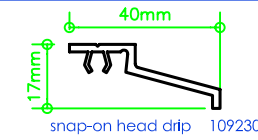

snap-on head drip 109230

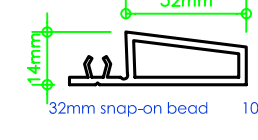

32mm snap-on bead 109231

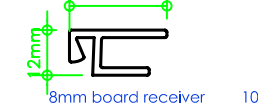

8mm board receiver 109286

cill extensions

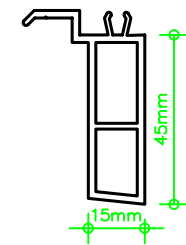

cill frame extension 110046

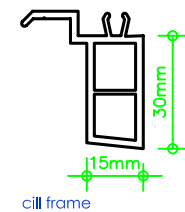

cill frame extension 110047

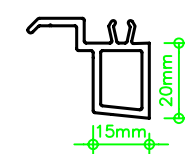

cill frame extension 110048

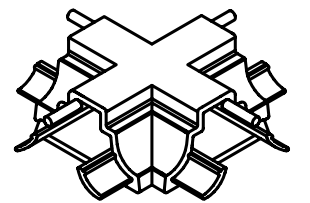

Cruciform 109113

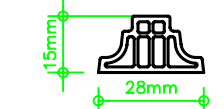

Georgian bar 109114



Georgian bar 109275



Georgian bar 109276

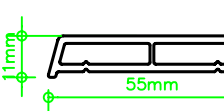

Georgian bar 109277

georgian bars